

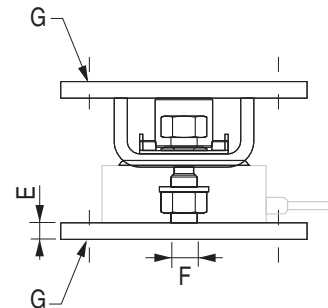

Capteur vendu séparément
Load cell sold separately

- Conçu pour le pesage de cuves et silos
 - Construction en acier inoxydable
 - Dispositif anti-soulèvement intégré
 - lame de blocage des efforts latéraux
 - Conception compacte, installation facile
-
- *Designed for tank or silo weighing*
 - *Made of stainless steel*
 - *Lift-off prevention device included*
 - *Plate system against lateral forces*
 - *Compact design and easy installation*

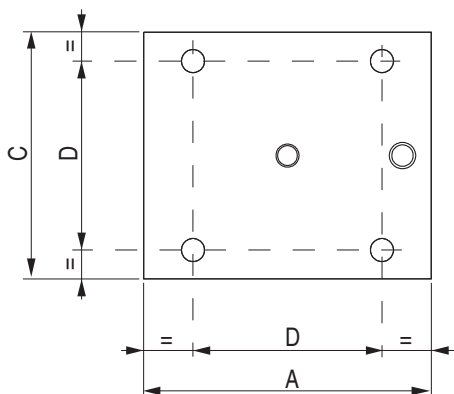
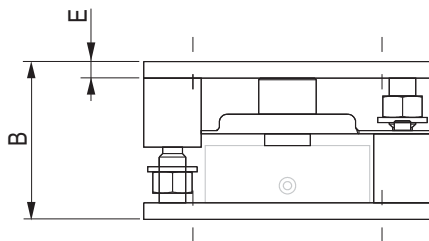

Capacité R10X R10X capacity	A	B	C	D	E	F	G (x8)	Poids Weight
1 ... 15 t	175	96	150	115	10	M16	Ø14	6 kg
30 t	230	118	200	160	10	M20	Ø17	10 kg

Capteur - Load cell R10X	SILOKIT-R	
	1 ... 15 t	30 t
Force horizontale maximum Maximum horizontal force	8 kN	10 kN
Force maximum à l'arrachement Maximum lift-off force	20 kN	35 kN

Toutes dimensions en mm - All dimensions in mm



BP501 - F-74105 Annemasse Cedex
Tél. : (+33) 4 50 87 78 64
Fax : (+33) 4 50 87 78 42
E.mail : info@scaime.com



Téléchargez tous
nos documents sur :
Download all
our documents on :
www.scaime.com

Agent